

Thesis Exhibition

MFA
&
MDes

2013

Contents

3 <i>Foreword</i> Christopher Ozubko	7 Jared Bender	17 Stephanie Klausling
4 <i>About the Exhibition</i> Sylvia Wolf	8 Phillip Carpenter	18 Joshua D. Nelson
5 <i>The Fruitful Season</i> Lauren Palmor	9 Carly Cummings	19 Adriel Rollins
	10 Lacy Draper	20 Travis-David Smith
	11 Mike Fretto	21 Melanie Wang
24 Contact Information	12 Dakota Gearhart	22 Marcus James Watson
25 Acknowledgements	13 Kari Gaynor	23 Ryan Weatherly
	14 Meg Hartwig	
	15 Margarita Iordache	
	16 Dave Kennedy	

Foreword

EVERY YEAR I LOOK FORWARD to the exhibition at the Henry Art Gallery that showcases the work of our graduate students. For two years these students have been forging a course of inquiry, investigation, and experimentation while benefitting from constructive interactive relationships with fellow colleagues and a faculty of professionals. Students and faculty from diverse cultural, educational and professional experiences come together to engage in critical discourse that challenges and strengthens students' understanding of art and design theory, research methodology and practice.

During their time here, students take a combination of graduate studios, seminars, art history courses, and directed independent study projects that culminate in a graduate thesis project, exhibition, and document. A strong commitment and dedication to the process of creating and sound critical thinking is also expected of the graduate-level student. They are encouraged to identify and expand their own voices as artists and designers. As educators, it is our goal to prepare our graduates not only to be skilled artists and designers, but also to be leaders in their area of study, offering sophisticated approaches to imagery and insightful perspectives within our global society. This attention to educational outcomes is why the UW School of Art has been recognized as one of the top graduate programs in the United States.

This year, the 17 graduate candidates are comprised of two groups: 12 MFA (Master of Fine Arts) students from the Division of Art, and five MDes (Master of Design) students from the Division of Design.

Please celebrate with us the outstanding achievements of the class of 2013.

CHRISTOPHER OZUBKO, *Director, School of Art*

About the Exhibition

THE HENRY ART GALLERY WAS founded as Washington State's first art museum in 1926 by Seattle entrepreneur Horace C. Henry, on the principle that art stimulates inquiry, fosters knowledge, and builds healthy communities. Today, the Henry is internationally recognized as a pioneer in the research and presentation of contemporary art. We engage artists to consider the museum as a studio or laboratory for creativity, and our exhibitions and programs invite audiences to push the boundaries of traditional thinking. In all that we do, we live our mission: to advance the art, artists, and ideas of our time.

For decades, the Henry has partnered with the University of Washington's School of Art in hosting its Master of Fine Arts (MFA) Thesis Exhibition. We are delighted to have added the recently designated Master of Design (MDes) degree. Our presentation of the MFA & MDes Thesis Exhibition is a hallmark of our commitment to supporting artistic innovation and a culture of creativity campus-wide. We serve as a cultural resource and training ground—opening our doors and resources without charge—for over 50,000 students, faculty, and staff. The museum actively participates in the academic life of University students by offering jointly-developed courses, student internships, practicums, and work study opportunities, and we collaborate with over 20 academic departments and 10 other units across campus. The Henry encourages access to and research of the 25,000 objects in our permanent collection through our Elenaor Henry Reed Collection Study Center, the only facility of its kind in the region, where visitors can study from original works of art.

It is a pleasure and a privilege to celebrate the achievements of this year's graduates in art and design! For many of these students, this has been their first experience working with a professional museum staff and crew. Special recognition goes

to Henry Head Preparator and Exhibition Designer, Jim Rittiman, an artist himself, who has worked with students throughout the year to develop their installations and realize their visions. Jim has been facilitating the MFA Thesis Exhibition since he arrived at the Henry in 1983. Thanks also go to our colleagues at the School of Art, in particular Chris Ozubko, Director; Jamie Walker, Associate Director; and members of the faculty for partnering in this initiative. But above all, we thank this year's graduates for making the art that is the subject of this exhibition and for sharing with us in this important juncture in their lives. We applaud them for their educational achievements and wish them the very best as they launch their careers. Congratulations to the 2013 recipients of the School of Art's Master of Fine Arts and Master of Design degrees!

SYLVIA WOLF, *Director, Henry Art Gallery*

The Fruitful Season

Lauren Palmor

PhD Student, Department of Art History

SPRING AT MOST ART SCHOOLS is a fruitful season. It is a time when emerging artists harvest the yield of their individual practices and present it to the public.

To arrive at this juncture, the students in the MFA and MDes programs have engaged in dialogues and explorations that reflect their faith in the creative process and their respective means of expression. Over the past two years, these artists and designers have been given time, space, and license to work in a variety of forms and media, developing and refining their mastery of matter and meaning. From the School of Art building to Sandpoint and the CMA, each contributor to this exhibition has had to gain the knowledge required by their medium and marshal the patience required by its practice.

The University of Washington School of Art is clearly not interested in producing artists who share a unified perspective, and therefore identifying a common thread in the work of seventeen inventive individuals is an ungraspable task. However, in each field of practice, comparable themes emerge within their distinct context, demonstrating that all these artists have stretched with confidence beyond levels of personal comfort, past previously established conventional boundaries and conceptual limitations.

To showcase their work in visual and industrial communication, design students at UW have invested considerable energy in exploring the varied questions posed by ideas related to education, community engagement, and technology. As a practitioner of industrial design, ADRIEL ROLLINS celebrates his

materials while appealing to the senses. By employing digital and manual skills in his practice, he acknowledges the innumerable possibilities inherent in his discipline. In her visual and technological studies, MELANIE WANG visually maps the rhythms and patterns of language. Her resulting work encourages viewers to engage with grammar and meaning by locating graphic equivalents for the structures of speech.

Design students at UW have also partnered with other institutions and availed themselves of sundry environments to pursue their practice beyond the confines of the School of Art. MIKE FRETTO teaches design in open workshops in order to embolden individuals to articulate their passions through graphic design. By helping others express themselves visually, he calls attention to design's potential capacity to function as a means for building community. In his work in the field of healthcare, JOSH NELSON investigates design as an instrument for understanding the experiences of chemotherapy patients. By identifying links between data, healthcare providers, and patients, Nelson seeks to assemble these relationships into new ways of addressing cancer care. KARI GAYNOR draws on her perspective as a designer to explore the unique social problems associated with the historic Pioneer Square area in downtown Seattle. By viewing a distressed neighborhood from a visual, experiential, and retail perspective, Gaynor tells the story of the numbered victories and losses that can be experienced within these few city blocks.

Those working in 3D4M share a common drive towards that which is tangible and technically complex. A passion for problem solving and an affinity for recycled and found materials can be observed in the work of MEG HARTWIG and STEPHANIE KLAUSING. Hartwig uses sculpture and construction to identify commonalities between context and matter. By placing her work in specific sites, she highlights the limits and potentialities of space, place, and making. Klausning focuses on the essential elements of form and process. Her thoughtful and sensitive communion with clay connects her own endeavors with those of the generations of ceramics practitioners who preceded her.

Works by JARED BENDER and LACY DRAPER address the body, labor, movement, and the trappings of human endeavor. In his tool wall hieroglyphs, Bender contemplates the possibilities presented by manual labor and human history. Draper's corporeal investigations point to strength, swiftness, movement, and the ways in which these things can and cannot be quantified through visual practice.

MFA students of painting and drawing have all reached beyond the limitations of practice to which they had previously grown accustomed. TRAVIS-DAVID SMITH has refused to confine himself to one medium, instead committing his work to acts of remembrance. His meditations on custom, place, and poetry take the form of ritual performed both inside and outside the studio space. MARGARITA IORDACHE employs the tools of painterly representation to convey her ideas on belief and narrative. Her paintings construct and deconstruct understandings of traditional religious tropes, making visual her personal reflections on faith and art.

MARCUS WATSON challenges notions of the male gaze, transposing the element of queer American experience into the realm of appearance and surveillance. By drawing on his command of the elements of color and scale, Watson makes powerful representations of social contrasts and psychologies of experience. In her portrait experiments, CARLY CUMMINGS focuses on the human face and the performance of expression. While considering diverse variables, such as psychology, behavior, and color, Cummings paints confessional moments and compositional moods. RYAN WEATHERLY'S studies of the face are the result of gestural distortions and chromatic tensions. He paints atypical states of mind with hallucinatory disquiet, engaging with portraiture as something that conceals as much as it clarifies.

Judging by the displayed works, practitioners of photomedia at the University of Washington revel in that which is socially charged, performative, and complex. Here one may observe a comfort with ambiguity, an audacious starting in the middle of an idea and then endeavoring to find its beginning as well as

its end. PHILLIP CARPENTER has reached beyond photography, applying critical material investigations to the problem of the space between things. By making negative space physical, his work endeavors to uncover the instruments of closeness, exchange, and human relationships. DAKOTA GEARHART addresses her pursuit of empathy by confronting emotional adeptness through surprising means. By negating the expressive distances between people, species, and spaces, her videos challenge the condition of the other and its relation to the self. DAVE KENNEDY'S respect for objects also aligns with matters of identity. Kennedy uses allegory and evidence to probe the world around him through cross-media interpretations of personal encounters.

This exhibition celebrates two years of time, support, and practice in various media and a variety of spaces. Addressed as a single display, this collection of undertakings is saturated with diverse approaches and individual experiments. While this exhibition is a thesis show, it is by no means a culmination of its participants' distinctive pursuits. To describe it as a "culmination" might imply that here one might find some kind of completion or an endpoint of a terminal experience. Rather, this is but a way station on the road towards ultimate accomplishments, deeper reflection, and heightened confidence. In other words, this is a celebration of a rich harvest and the seasonal abundance of artistic fruits.

Jared
Bender

Lineage [detail]
Concrete
168" x 60" x 6"



Phillip Carpenter

THIS PAGE

*Joe Wills, Nashville, TN &
The Space Between
Two People.*

Unfired porcelain, painted
plywood, & color photograph

OPPOSITE

*The Space Between a Truck
and Myself.*

Unfired manganese clay
15" x 10" x 7"



Carly Cummings

THIS PAGE

Kat [detail]
Oil on canvas
72" x 90"

OPPOSITE

Marcus [detail]
Oil on canvas
36" x 180"



Lacy Draper

*Intro 101: Conditioning
the Conditioned [detail]*
Film & objects



Mike Fretto

BELOW

Design for Us
Participant Posters
Community workshop
participants with
their final posters;
screen print on paper
13" x 19" each

OPPOSITE

Design for Us
Community advocacy
design workshop



Dakota Gearhart

*The Observatory of One to
Another Without Doubt,
Hesitation, or Fear*
Xeroxed ash, watered down
collagen, repurposed spruce,
silvered polyethylene, &
digital light projection



Kari Gaynor

*The Ups and Downs of
Pioneer Square*
Single-channel video
(approx. 20 minutes)

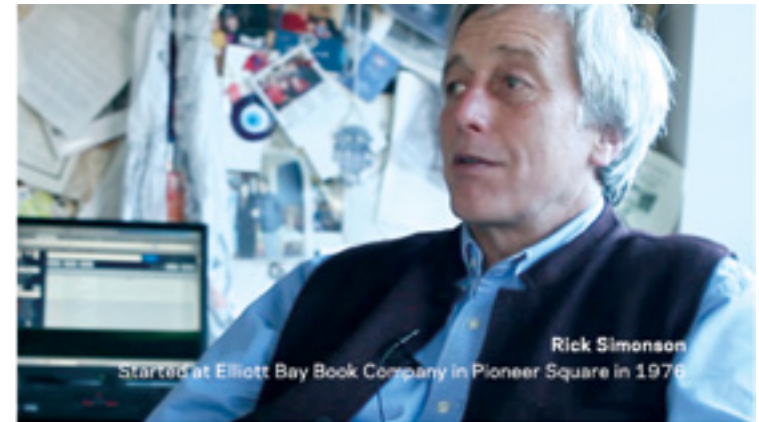

Meg Hartwig

Load/Back n' Forth

Rockin' Horse

Created, found, and
ordered significant objects
within vicinity
180" x 264" x 60"



Margarita Iordache

"They found Him in the temple, sitting in the midst of the teachers, both listening to them and asking questions" Luke 2:46

Oil on canvas
48" x 48"



Dave Kennedy

THIS PAGE

Danny

Ultrachrome archival
pigment photograph
38" x 38"

Rochelle

Ultrachrome archival
pigment photograph
38" x 38"

OPPOSITE

Dave

Ultrachrome archival
pigment photograph
38" x 38"

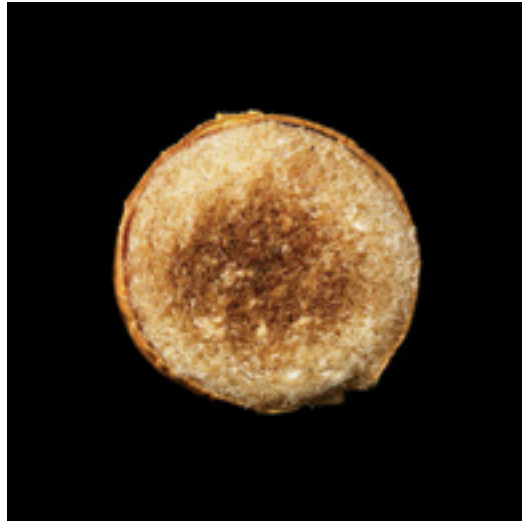

Stephanie Klausing

THIS PAGE

parking lot plant planter

Ceramic & plant
13" x 9" x 11"

OPPOSITE

planter, dead plant

Ceramic & plant
15" x 27" x 16"



Joshua D. Nelson

Chemo Kids, Collaborative Educational Game
Digital & physical models



Adriel Rollins

THIS PAGE

3-Legged Tractor [sketches]
 Stack laminated solid hardwood,
 steel, & oil/wax finish
 26" x 26" x 17"

OPPOSITE

Treble Clef Wall Desk [sketches]
 Micro-laminated teak veneer,
 steel, solid wood, oil/wax finish
 32" x 34" x 11"

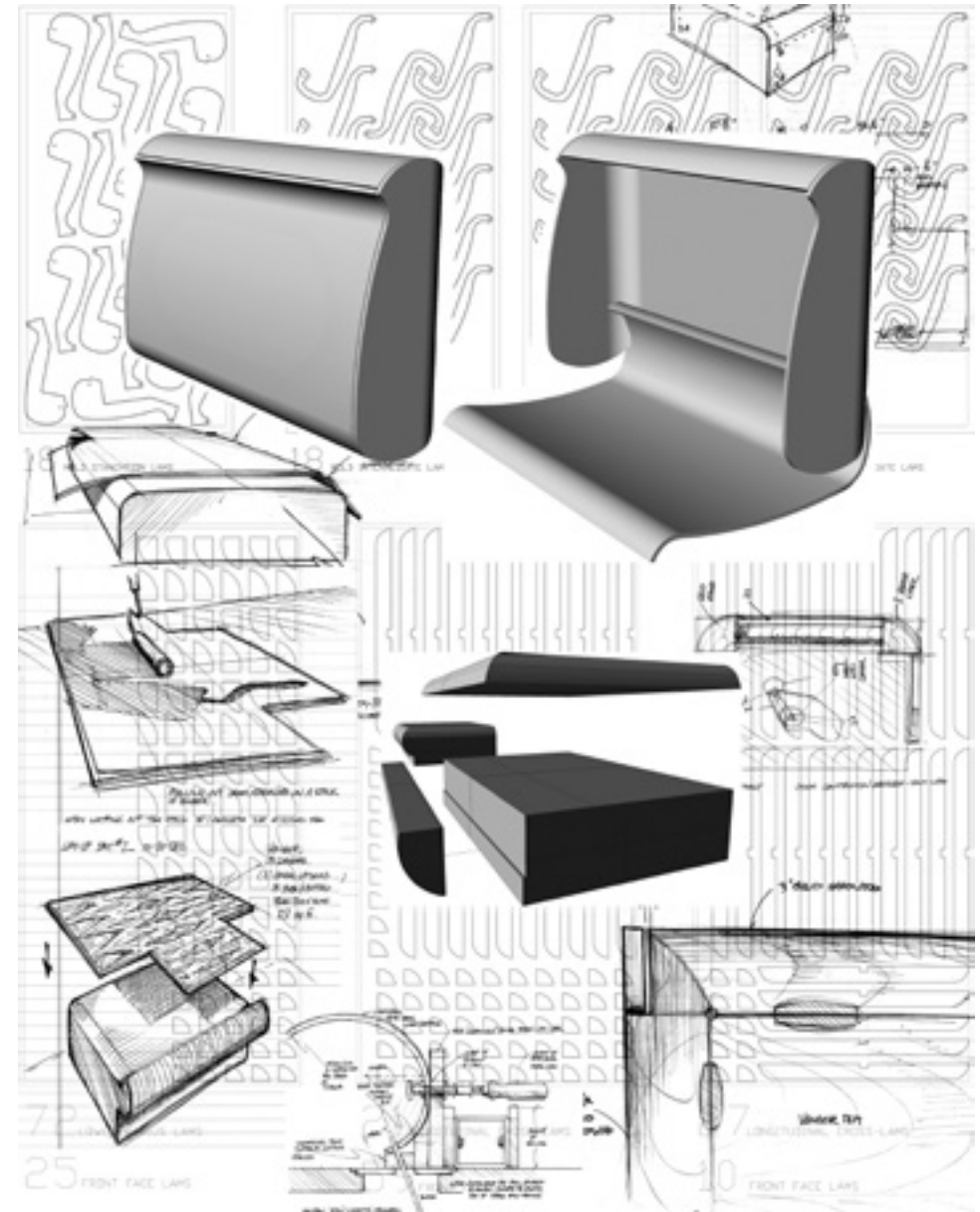
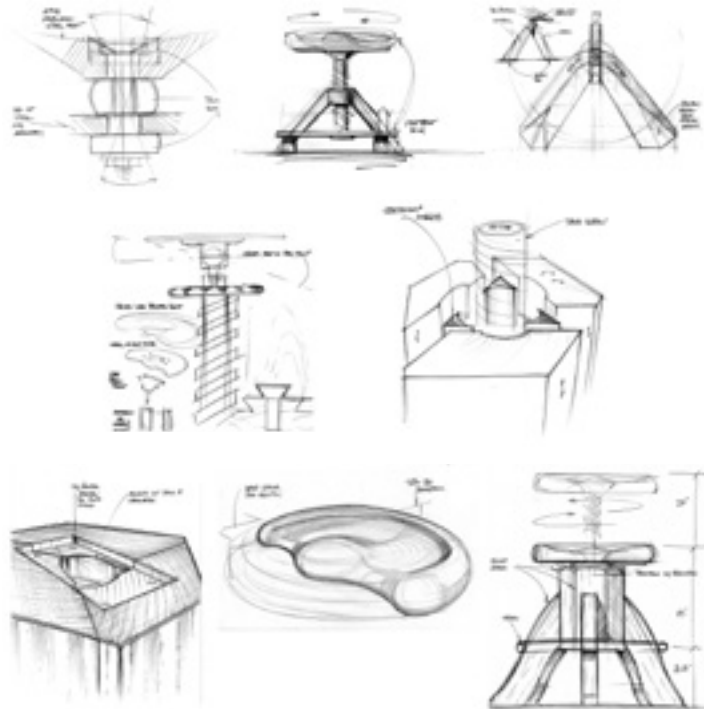
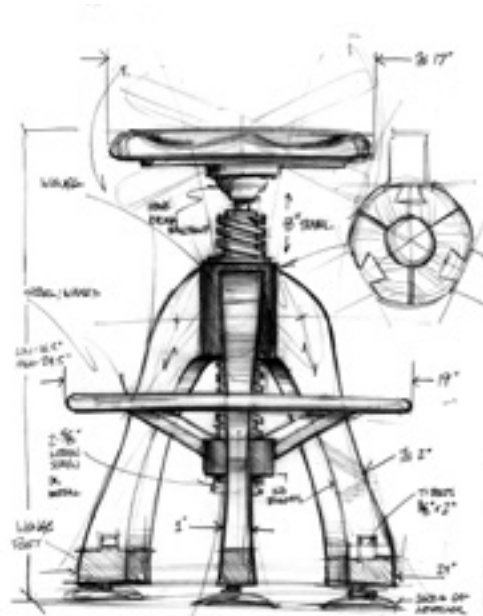

Travis-David
Smith

*standing between
impressions*
Archival pigment print
on Tyvec
60" x 80"



Melanie Wang

Parts of speech experiment
Data visualization using the
Processing language

road now it was day. The **BOY TURNED** in the blankets. Then **HE OPENED** his **EYES**. **HI**, Papa, **HE**
In case they had to abandon the cart and make a run for it. Clamped to the handle of the cart **WAS** a chr
Below in the little valley the still gray serpentine of a river. Motionless and precise. Along the shore a burd
D the **RIVER** by an old concrete bridge and a few **MILES** on they **CAME** upon a roadside gas station. **T**
HALT APRON and **FOUND** the **TANK** for the pumps. The **CAP WAS** gone and the **MAN DROP**
in place. The windows intact. The **DOOR** to the service bay **WAS** open and **HE WENT IN**. A standing
al barrel full of trash. **HE WENT** into the office. Dust and ash everywhere. The **BOY STOOD** in the do
PICKED UP the **PHONE** and **DIALED** the **NUMBER** of his father's house in that long ago. The **BOY**
CART off the road and tilted **IT** over where it could not be seen and **THEY LEFT** their **PACKS** and
T in the floor decanting them of their dregs one by one, leaving the **BOTTLES** to **STAND** upside down d
slutlamp to light the long gray dusks, the long gray dawns. **YOU** can **READ ME** a **STORY**, the **BOY S**
wing over the road and the sagging hands of blind wire strung from the blackened lightpoles whining thinly
MOTELS. EVERYTHING as it once had been save **FADED** and **WEATHERED**. At the top of the
country below them. **HE GOT** the **BINOCULARS** **OUT** of the cart and **STOOD** in the road and **GL**
L. The **BOY** leaned on the cart and adjusted the **WHEEL**. What do **YOU SEE?** the **MAN SAID**. Noth
he standing trees to where he'd seen a running ledge of rock and **THEY SAT** under the rock overhang an
s just the dripping in the woods. When it had cleared they went down to the cart and pulled away the tarp
he boy trying to warm him. Wrapped in the blankets, watching the nameless dark come to enshroud them. **T**
OK the **BOY'S HAND** and **THEY WENT** to the top of the hill where the road crested and where the
he side of the hill **WAS** little more than a mote of light and after a while **THEY WALKED** back. Everyth
an **WE LEAVE** the **LAMP** on till I'm asleep? **HE SAID**. Yes. Of course **WE** can. **HE WAS** a long **TII**
SAID. Yes. Of course. **ARE WE** going to **DIE?** Sometime. Not now. And **WE'RE** still going south. Yes. So
is something? Yes. Of course **YOU** can. What would **YOU DO** if I died? If you died I would **WANT** to
CARRIED on the bleak and temporal winds to and fro in the void. Carried forth and scattered and carrie
re gray **DAY BREAK**. Slow and half opaque. **HE ROSE** while the boy slept and pulled on his shoes and

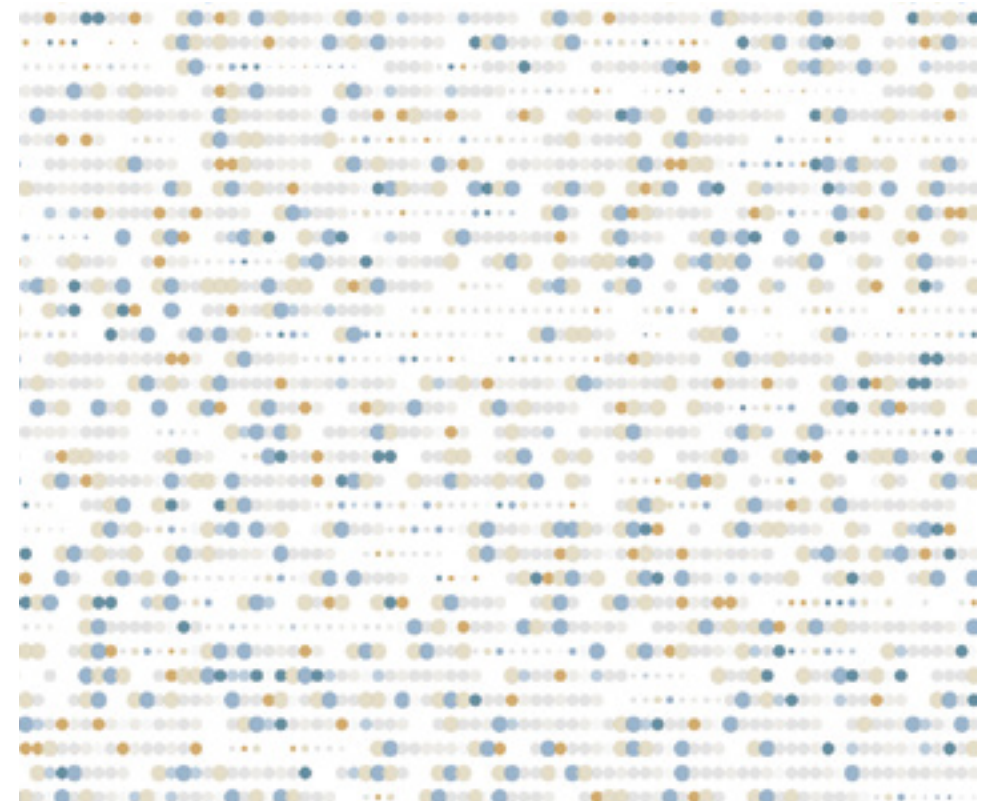

Marcus James
Watson

For Your Eyes Only
Oil on canvas
96" x 120"



Ryan Weatherly

Untitled [in progress]

Oil on canvas

92" x 172"

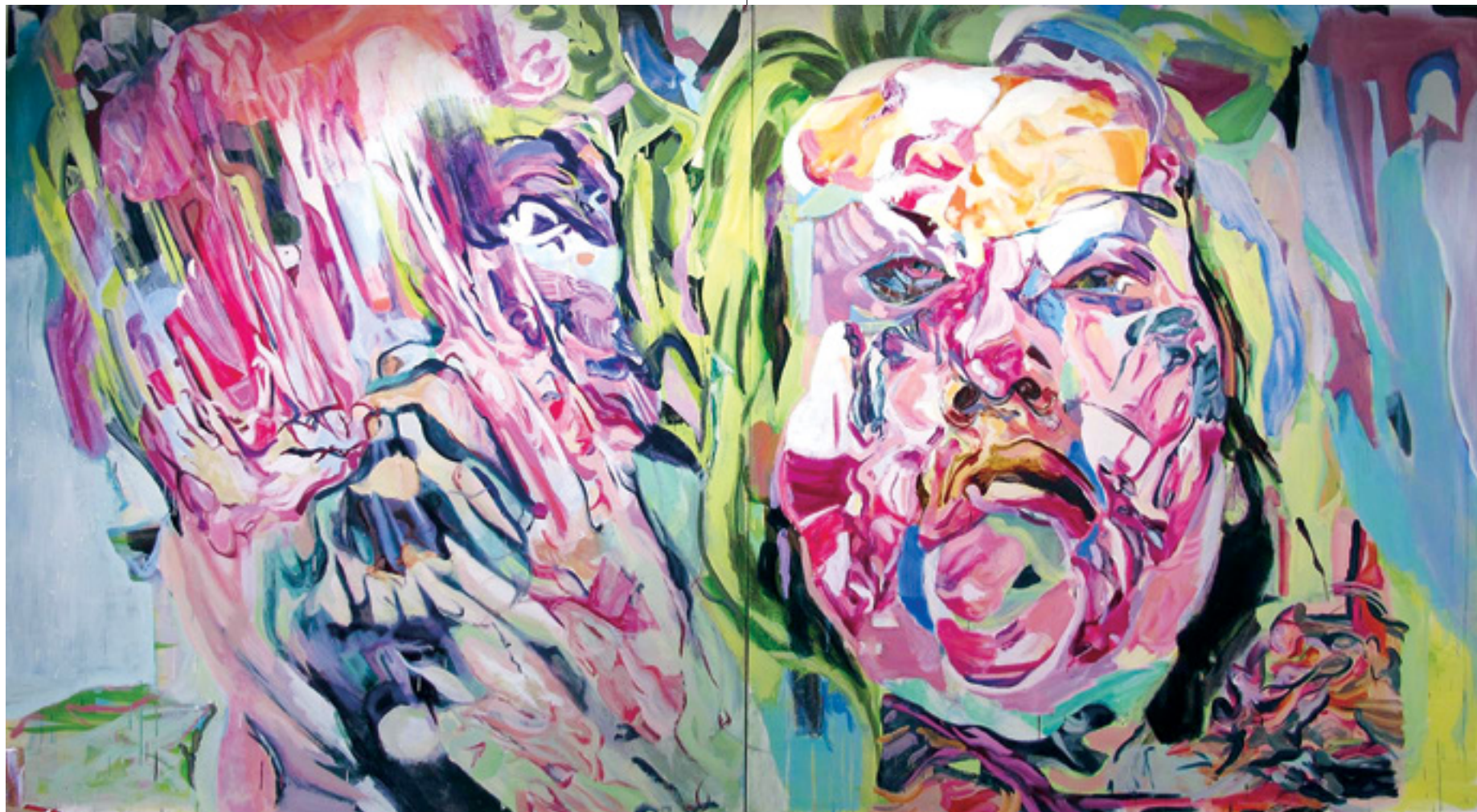

Master of Fine Arts

3D4M

Jared Bender
jared-bender.com
jared.r.bender@gmail.com

Lacy Draper
ldraper1@gmail.com

Meg Hartwig
[flickr.com/photos/meghartwig](https://www.flickr.com/photos/meghartwig)
meghartwig@gmail.com

Stephanie Klausing
stephanie.klausing@gmail.com

PHOTOMEDIA

Phillip Carpenter
phillipcarpenter.com

Dakota Gearhart
[dakotagearthart.tumblr.com](https://www.dakotagearthart.tumblr.com)
dakotaeriegearhart@gmail.com

Dave Kennedy
davekennedyimages.com
dave@davekennedyimages.com

PAINTING & DRAWING

Carly Cummings
carlyhelencummings@gmail.com

Margarita Iordache
rita2go@gmail.com

Travis-David Smith
travisdavidsmith@gmail.com

Marcus James Watson
marcuswatsonart@gmail.com

Ryan Weatherly
ryan.weatherly1@gmail.com

Master of Design

INDUSTRIAL

Joshua D. Nelson
jdnelsonid.com
jdnelson.id@gmail.com

Adriel Rollins
adrieldesign.net
adriel@adrieldesign.net

INTERACTION

Kari Gaynor
karigaynor.com
kegaynor@gmail.com

VISUAL COMMUNICATION

Mike Fretto
mikefretto.com
mikefretto@gmail.com

Melanie Wang
cargocollective.com/melaniewang
mkwang@uw.edu

School of Art Acknowledgements

DIVISION OF ART

Paul Berger
David Brody
Lou Cabeen
Rebecca Cummins
Ann Gale
Ellen Garvens
Layne Goldsmith
Philip Govedare
Denzil Hurley
Doug Jeck
Curt Labitzke
Zhi Lin
Amie McNeel
Helen O'Toole
Shirley Scheier
Akio Takamori
Timea Tihanyi
Jamie Walker
John Young
Mark Zirpel

DIVISION OF DESIGN

Sang-gyeun Ahn
Karen Cheng
Magnus Feil
Annabelle Gould
Tad Hirsch
Kristine Matthews
Dominic Muren
Christopher Ozubko
Axel Roesler
Douglas Wadden

DIVISION OF ART HISTORY

Susan Casteras
Meredith Clausen
Ivan Drpić
Patricia Failing
Sonal Khullar
Margaret Laird
Estelle Lingo
Stuart Lingo
Haicheng Wang
Marek Wiczorek
Robin K. Wright

ADVISORY BOARD

Judi Clark
Gary Crevling
John & Laurie Fairman
Jennifer Henneman
William Ingham
Gayle Jack
Harold Kawaguchi
Jack & Layne Kleinart
Linda LaResche &
Michael Von Korff
George & Alice McCain
Alison Milliman
Kierra Neher
Sheryl Rasmussen
Anne Traver
Kathie Werner

THANK YOU TO OUR CONTRIBUTORS & DONORS

GPSS
The Graduate School
The Henry Art Gallery
Lambda Rho Art Honorary Society
The School of Art

CATALOG DESIGN

Daphne Hsu, VCD '13

PRINTING

The Copy Company Printing & Imaging

SCHOOL OF ART

Box 353440
University of Washington
Seattle, WA 98195-3440

PHONE 206 543-0970

FAX 206 685-1657

art.washington.edu

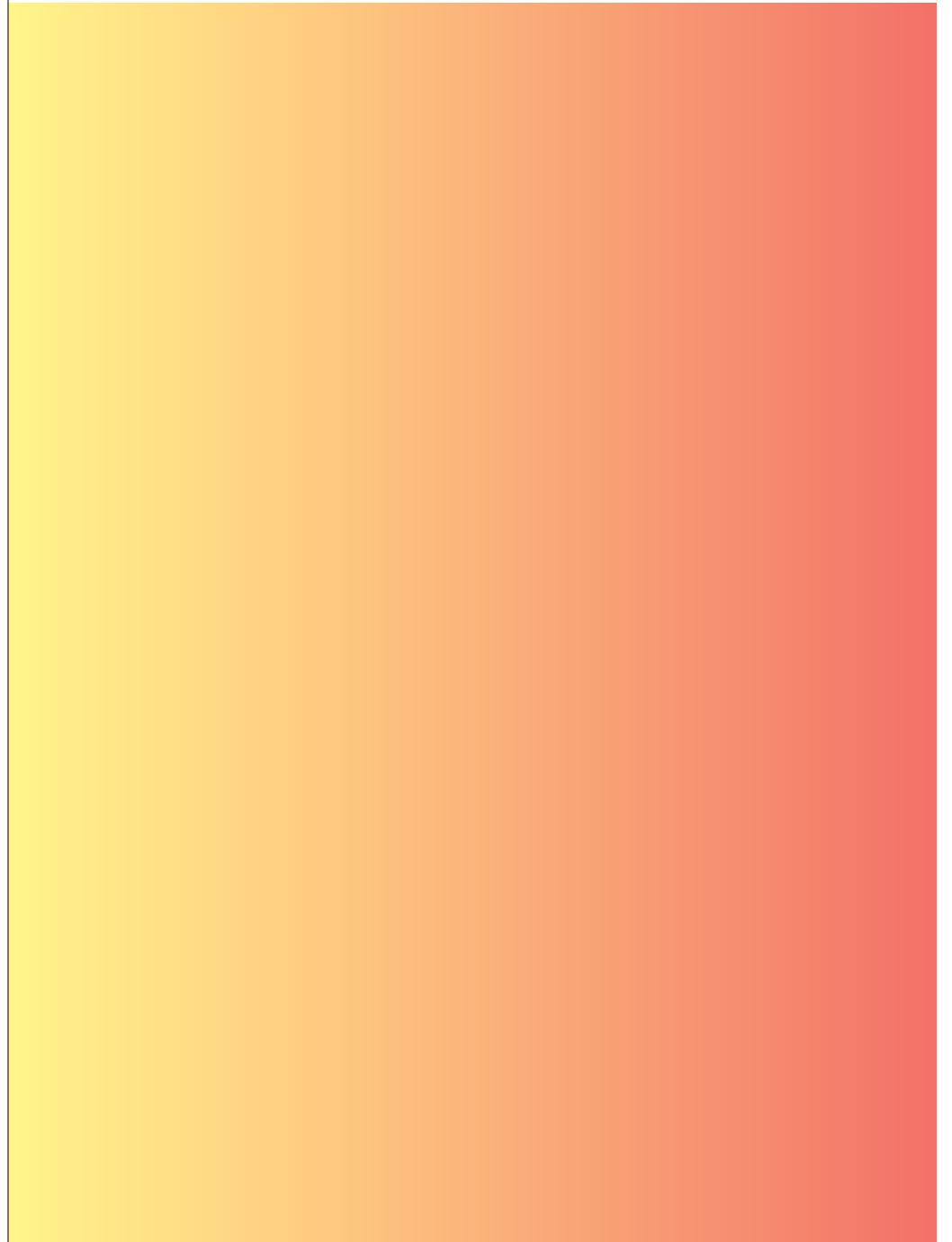

This is the fruitful season.